

PUBLIC ADDRESS AMPLIFIER

INSTRUCTION MANUAL

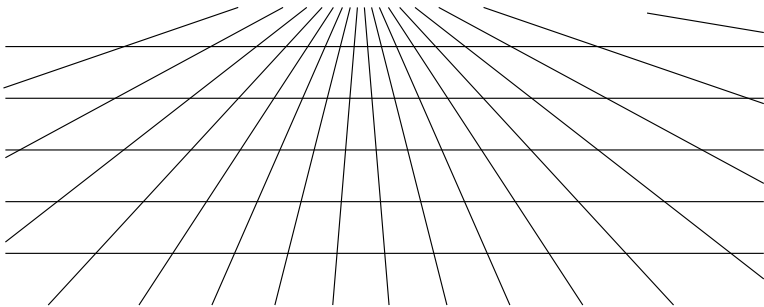

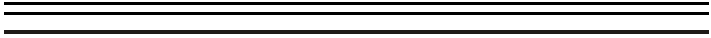
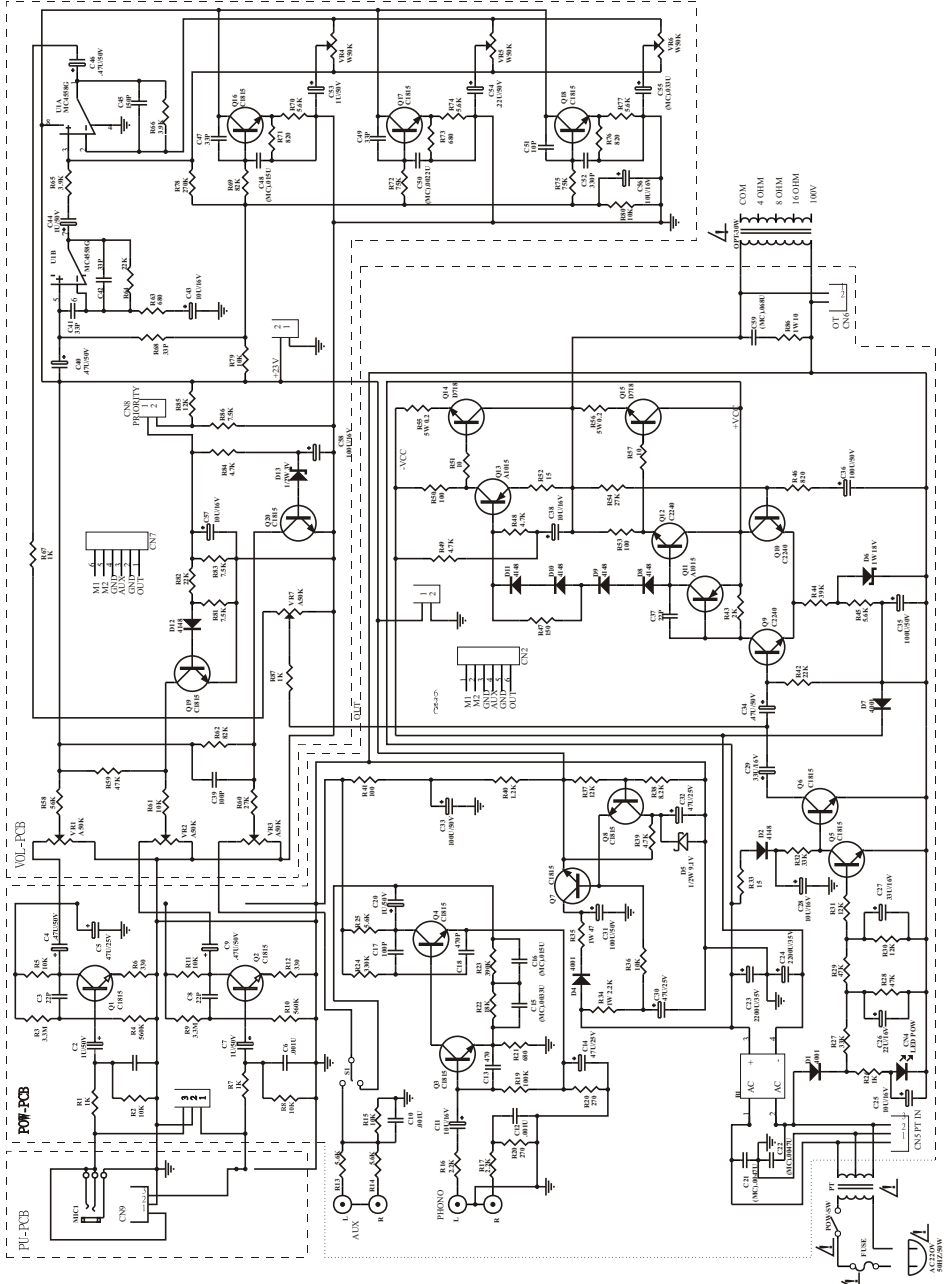

GENERAL DESCRIPTION:

For the convenience of the users, the AC Mains of the amplifier series is controlled by the power selector, it provide the two kinds of voltages: 110V-120V / 220V-240V

For greater operational flexibility, two Microphones can be inserted in the amplifier, on which also have "AUX" inputs, which can provide for the use of radio tuner, CD player and other high impedance, high power input .

The rear panel selector switch must be tuned in to "PHON" position when the amplifier is playing recorder.

"MIC", "AUX.CD", "PHON" positions are all set on volume controllers, which can freely adjust the volume needed by users.

You will find it safe and reliable to use the Series; AC selector is made of insulating material and the rear panel is installed with connecting-ground terminal. Any other components are all considered Safety-factor while assembling.

CAUTION

You shall hold the plug firmly to avoid the pull-out of power line and risk occurring when you pull the power line out from AC outlet.

The plug of power line for this unit should be pulled out from power outlet to cut down the power supply, when this unit isn't used for a long period.

⚠ CAUTION

Don't touch the screw around the ventilation holes in the bottom board. When heat sink working, the screw temperature rises higher

IF Connecting interference takes place in source circuit, THD will be more than 10%

⚠ This broadcast system, main unit should be placed on a solid

surface with a minimum distance of 1m from the back or side plate to the wall and. rot in the following environments of cases:

Moist place;

Under direct radiation of sunlight or other strong heat radiation;

no air ventilation:

To prevent the risk of fire or electrical shock, never expose this equipment to rain or dampness.

⚠ HANDLING THIS UNIT

Check if the power supply is being shut down, the power line is pulled out from outlet and other lines connecting this unit are also disconnected.

⚠ DON'T DISASSEMBLE THIS UNIT

Don't disassemble and repair the unit by yourself, otherwise it may induce electric shock or fires. If you can't remedy any occurred trouble according to the methods described in the Last of this manual, you must call a qualified technician or consult with our company, A forced using it may cause electric shock or fires.

SPECIFICATIONS:

Microphone Sensitivity: -55dB \pm 2dB

Aux.CD Sensitivity: -20dB \pm 2dB

OUTPUT POWER : 30W at 4 Ω load

FREQUENCY RESPONSES : 100Hz-18KHz \pm 3dB

DISTORTION : less than 1% (at 1KHz 1watts output)

Signal/Noise Ratio : More than-55dB

Hum or Noise level : 50mV

Tone Control Response :150HZ \pm 10dB; 1K \pm 10dB; 6K \pm 10dB

Puncture Voltage at 5mA, 5Sec : 3750V

Speaker outputs : 4, 8, 16ohms 100V

Dimensions : 320 (W) * 190 (D) * 80 (H) mm

Weight : 5Kgs

NAME OF FUNCTIONS

1. Power switch.
2. Master volume control.
3. 6kHz Tone control.
4. 1kHz Tone control.
5. 150 Hz Tone control.
6. PHONO/AUX Volume control.
7. MIC2 Volume control.
8. MIC1 Volume control.
9. AC FUSE holder.
10. AC CABLE.
11. PRIORITY control terminals.
12. Output terminals.
13. PHONO,AUX Selector switch.
14. MIC2 Input phone jack.
15. MIC1 Input phone jack.
16. PHONO jack (RCA).
17. AUX/CD jack (RCA).
18. Ground \perp .

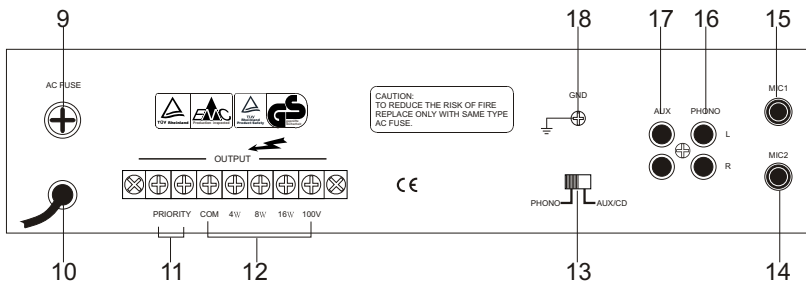
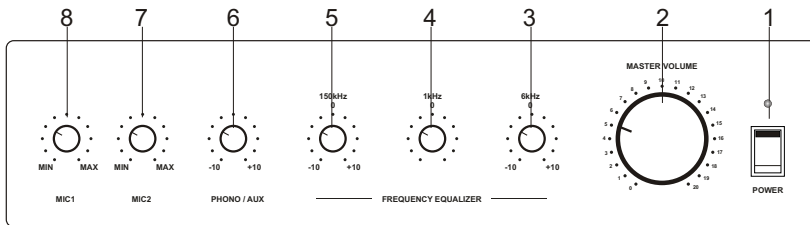

MUTE CONTROL (PRIORITY)

When the Terminals are short circuit, It will be shut down MIC2 , AUX and phono, MIC1 is Priority output.

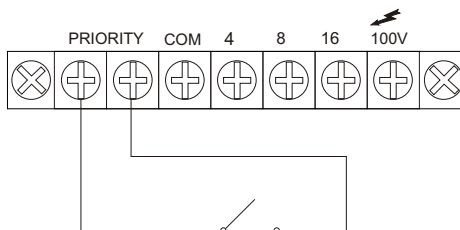

1. Avoid using or storing it in a place where it is very dusty.
 2. Also refrain from using it in direct sun or near a heater or stove or in a similar place of high temperature.
 3. Keep your recorded cassettes away from magnets, motors, or TV set generating magnetism.
- Also avoid storing them in a place of high temperatures. Magnetism and high temperature can cause added tape noise or erase the recorded materials.

Input Connection

Microphones

Three microphone inputs are provided. They used with unbalanced low impedance (30~600 ohms) microphone. The microphone with the unbalanced connection cable of 10-20m may be used depending on the microphone and its characteristic.

MIC-1, MIC-2

There TWO microphone inputs are unbalanced type and are provided with a double pole phone jack.

Unbalanced Lo Z Microphone

May also be connected to the single conductor shielded cable of unbalanced Lo Z microphone.

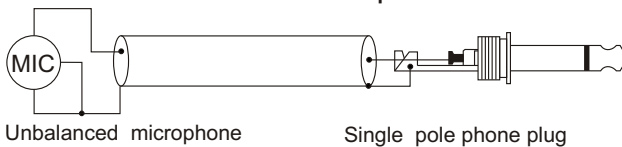

AUX/PHONE

A radio tuner, tape player, chime , mixer preamplifier, compact disk player or other high level input sources may be connected to the AUX inputs.



Should be selected either AUX or PHONO by using. The AUX/PHONE Selector switch on the rear panel. AUX & PHONO cannot be used at the same time.

Output Connection

Speaker Output

The amplifier may be used in conjunction with a speaker rated at 4, 8, 16 ohms or with 100-Volt constant-voltage speaker systems.

Low impedance speaker output : 4, 8, 16 ohm (balanced)

The low impedance 4, 8, 16 ohm terminal is provided for connection of a few large-output speakers when constant voltage speaker system is unnecessary or in case the distance between the amplifier and the speakers is short enough (less than 50m). It is requested that the total speaker load impedance be correctly matched to the output impedance (4, 8, 16 ohm) of the amplifier for most efficient transfer of power.

Be sure that total impedance of speakers Amplifier must be in equal, do not raise amplifier output power to above the permissible input power of speaker if the latter is smaller than the former. If the amplifier output power should be raised above it, by mistake, the speakers would be damaged.

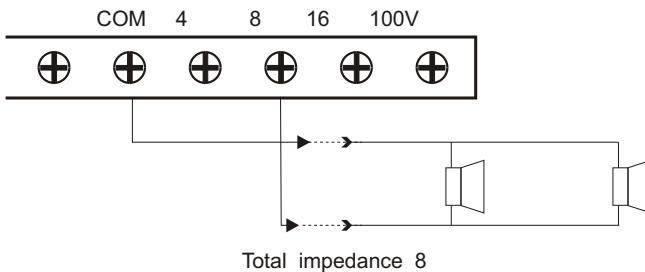
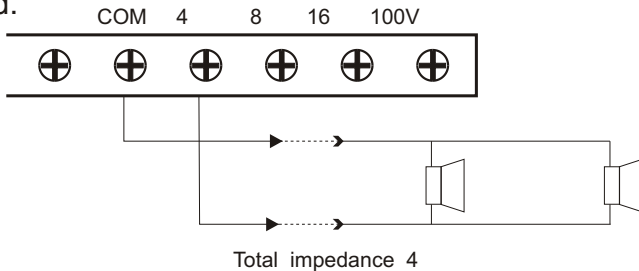

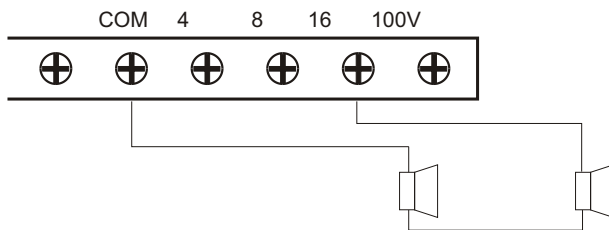

Total impedance 16

100 Volts speaker output (balanced)

When it is desired to operate the speakers from the distance, over 50 meters of the amplifier, it is recommended that line matching transformers be installed on the speaker units to prevent excessive line losses. This method of load matching known as the constant voltage distribution system eliminates the calculation of load impedance and series-parallel speaker arrangements. In this method, all speakers are connected in parallel.

These constant voltage outputs are most convenient for distribution of power when a number of speakers are installed. Each speaker must have 100-volt line transformer with a tap that gives the power desired for that speaker. The total number of power settings for all speakers should be equal to the amplifier power rating or less.

A speaker plug is supplied with this unit for a quick connection/disconnection to/from speaker screw terminal strip 100 volts.

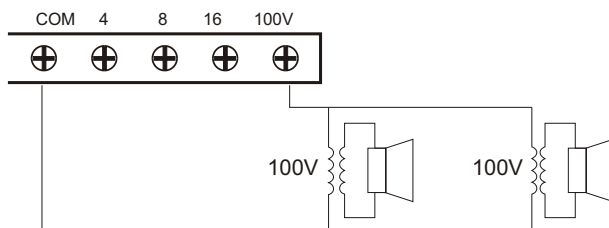

Total impedance 100V